

Assembly Instruction

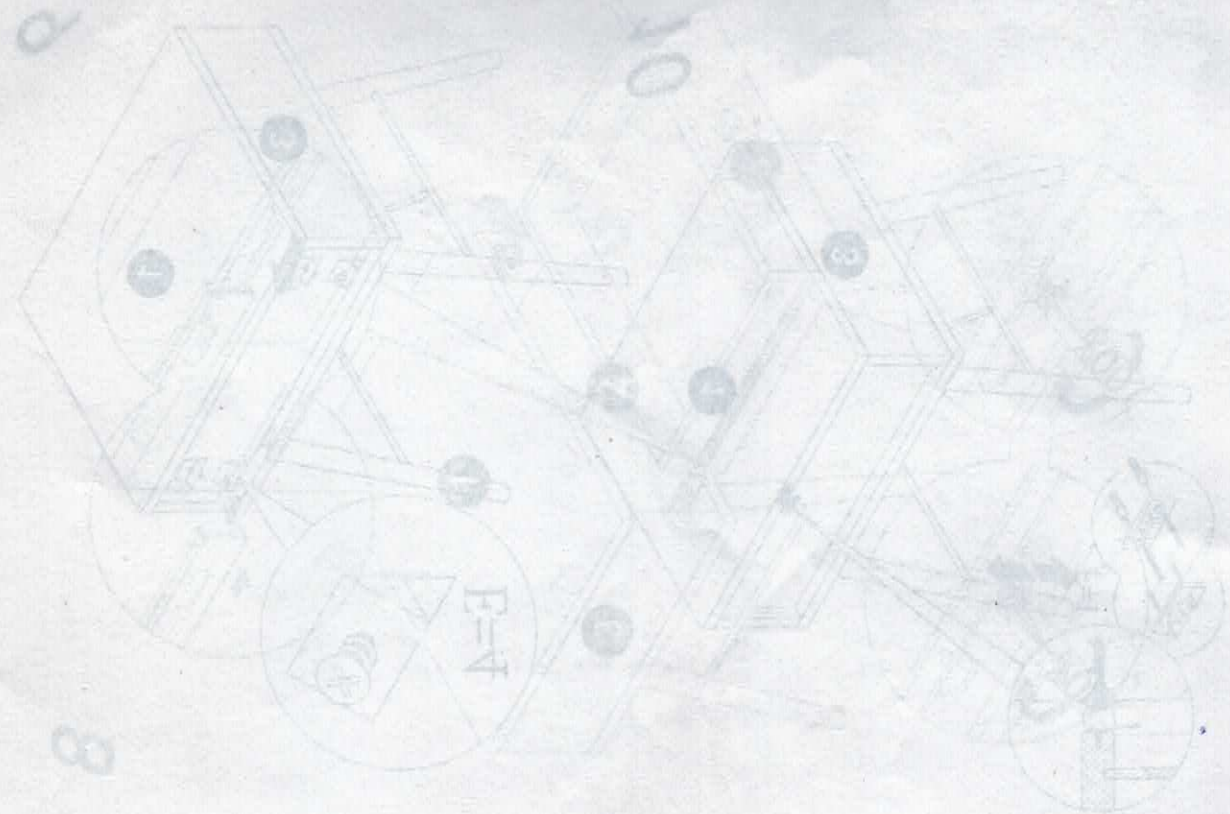

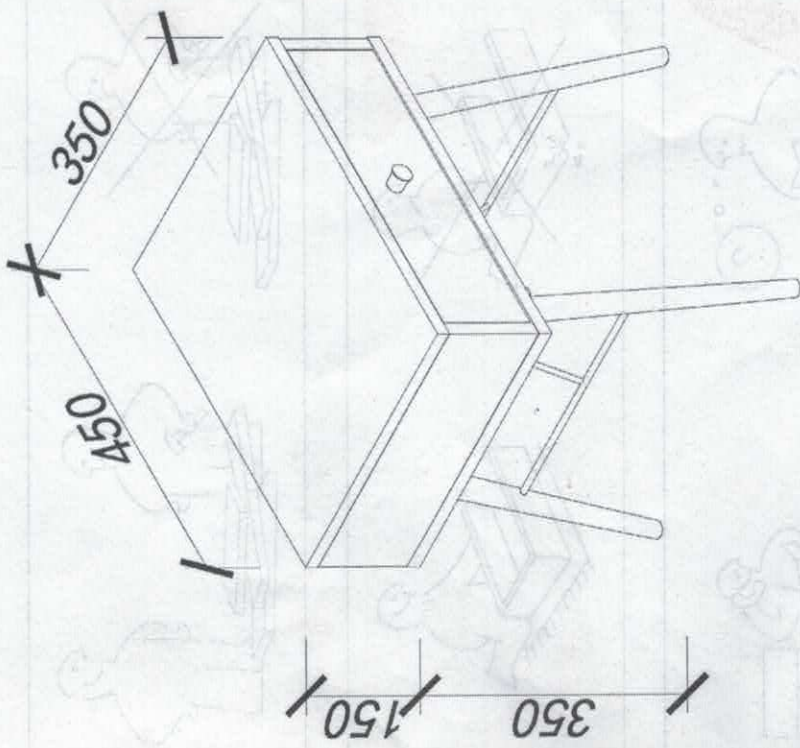
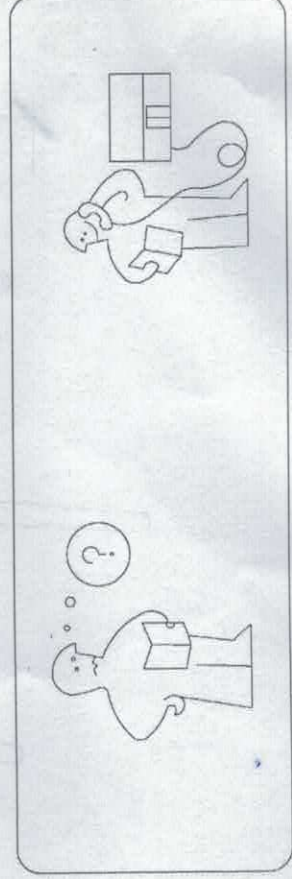
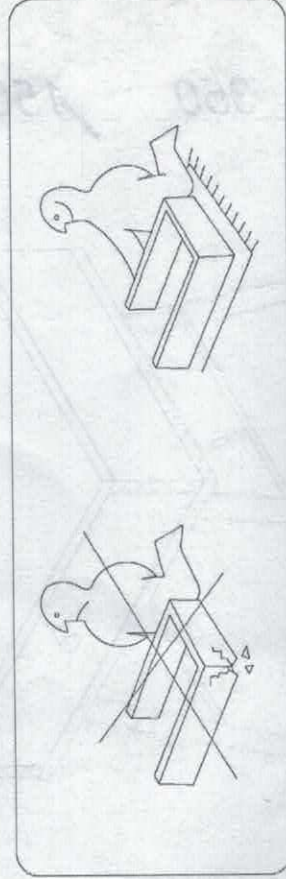
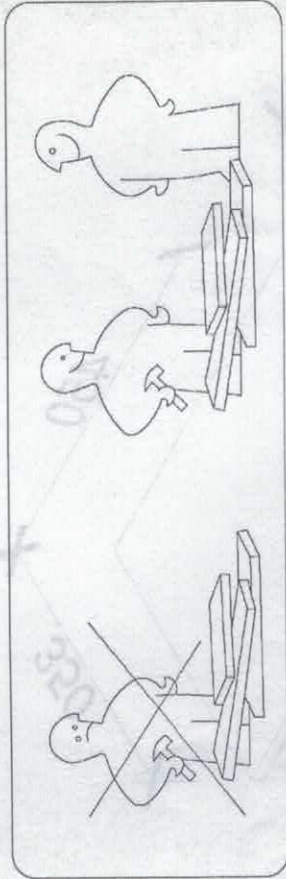
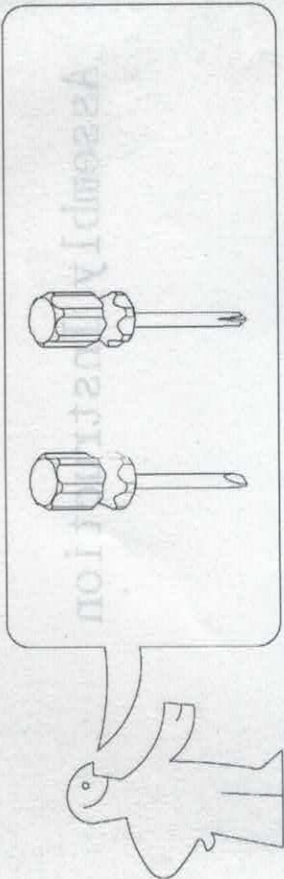

Panel No	Panel Sizes	Quantity
6	300*60*12	1
7	300*60*12	1
8	366*60*12	1
9	298*376*6	1

Panel No	Panel Sizes	Quantity
1	450*350*16	1
2	450*350*16	1
3	118*349*16	2
4	128*420*5	1
5	412*114*16	1

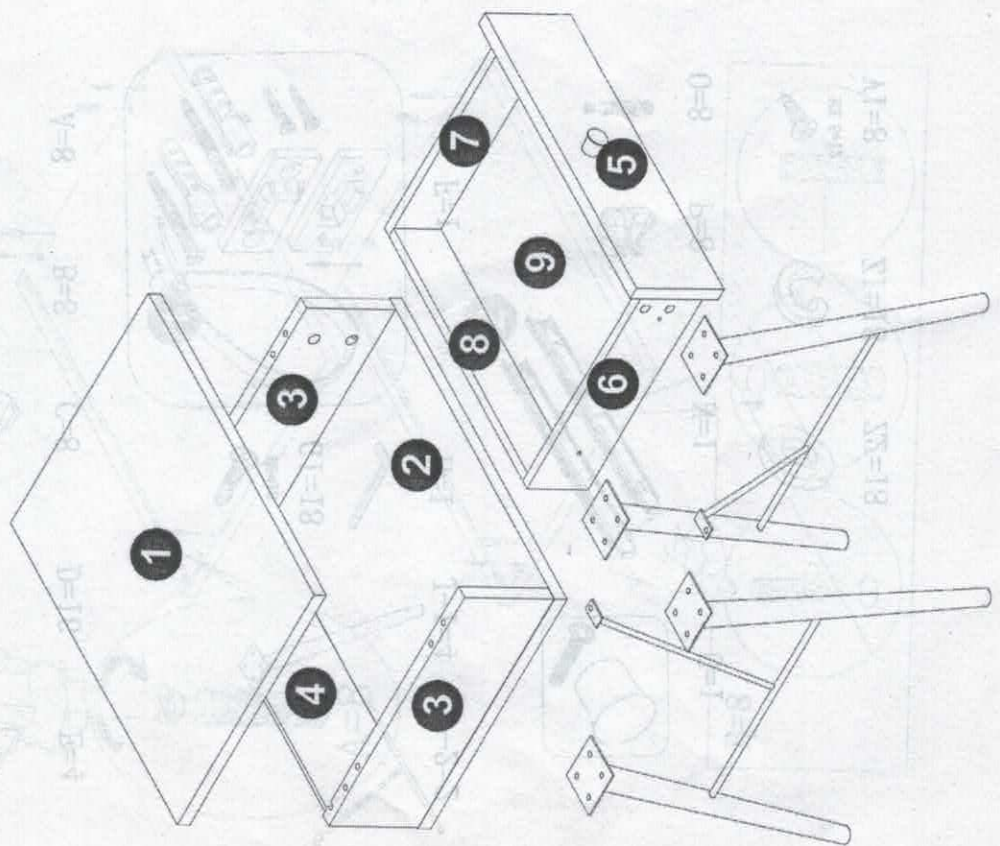

Fittings

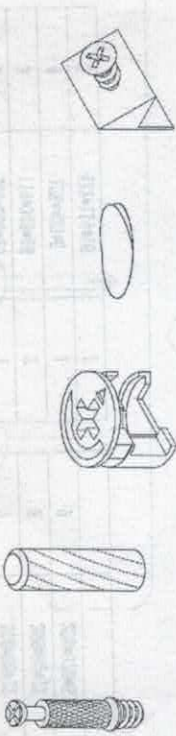

A=8 B=8 C=8 D=16 E=4

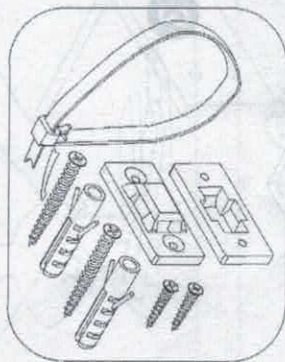

F=1



G1=18



H=1

J-1=4

J-2=2

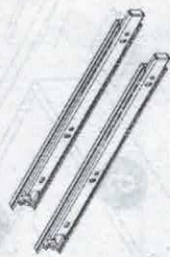

O=8

P=8

N=1

U=1



Z1=18



Z2=18



MB. 5*12

V1=8

1

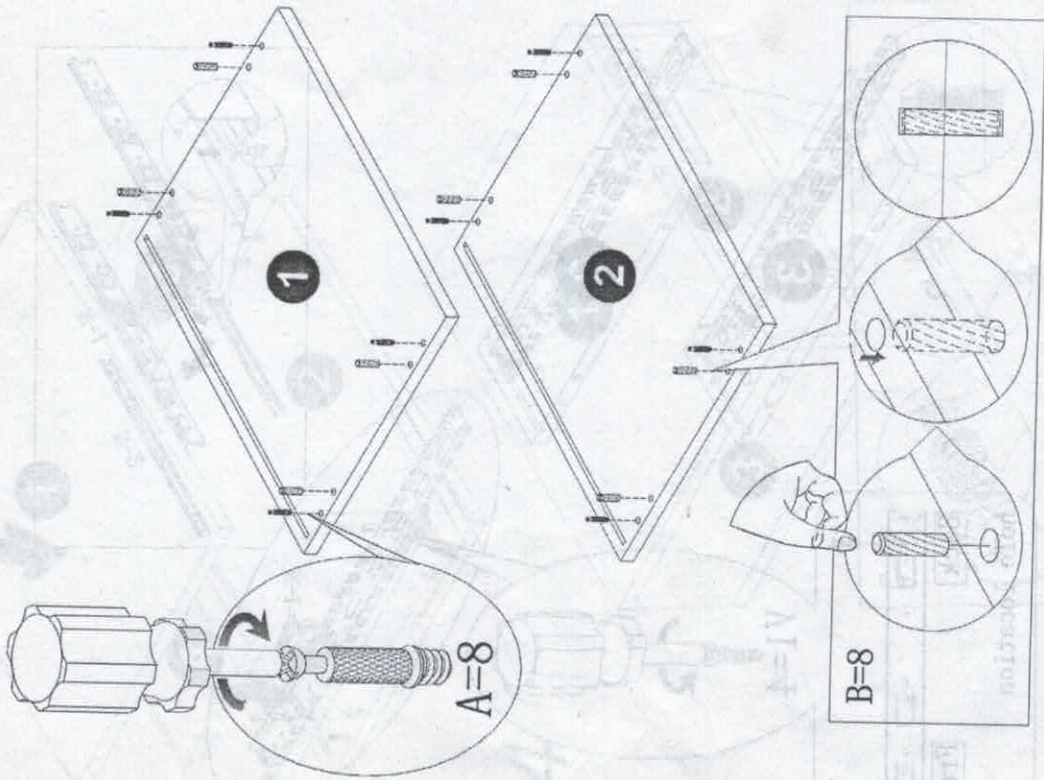

Fittings

2

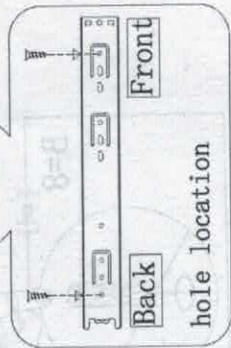
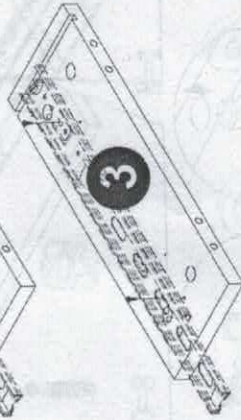
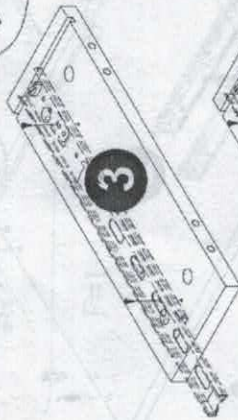
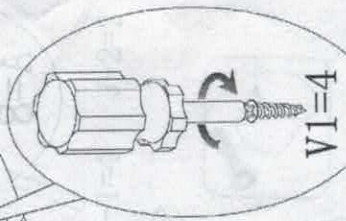
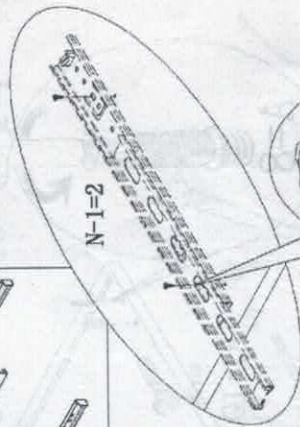
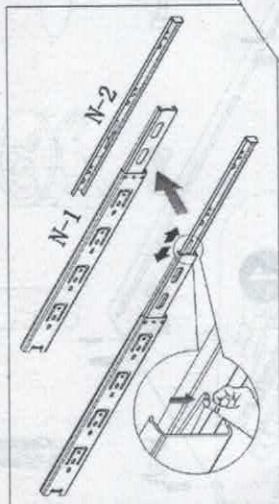

3

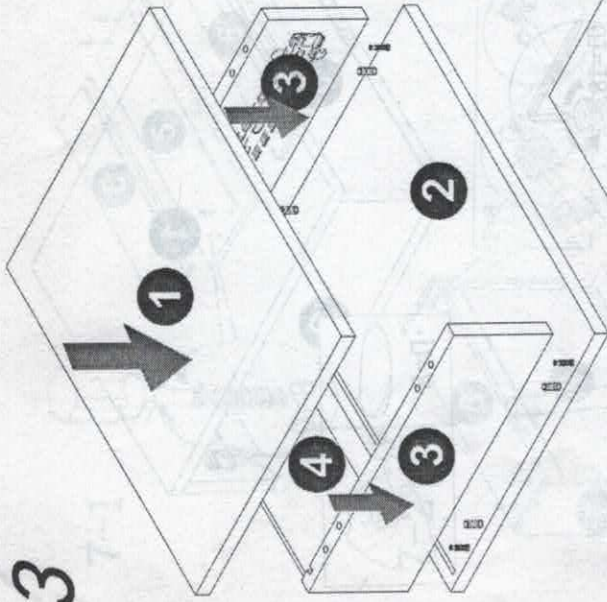

4

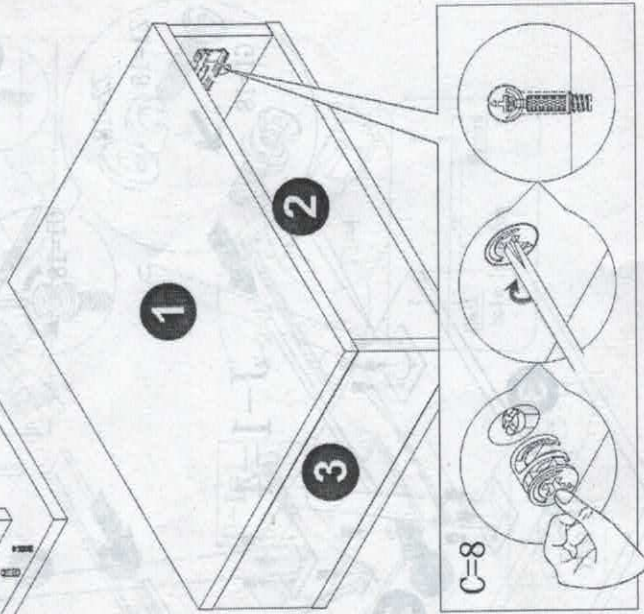

7

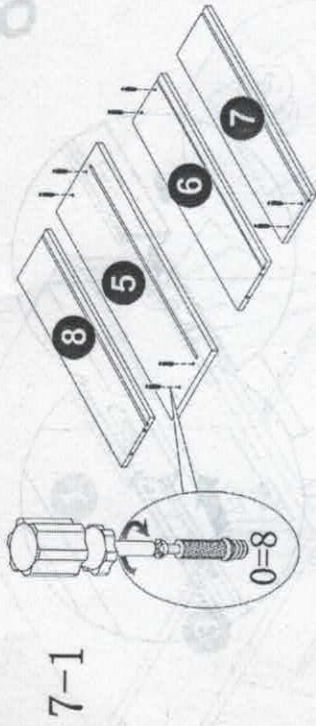

7-1

7-2

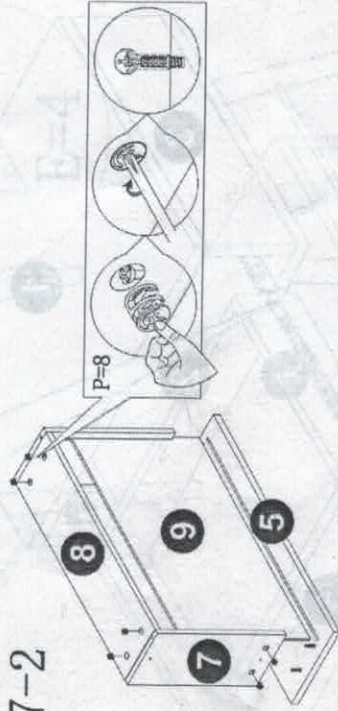

7-3

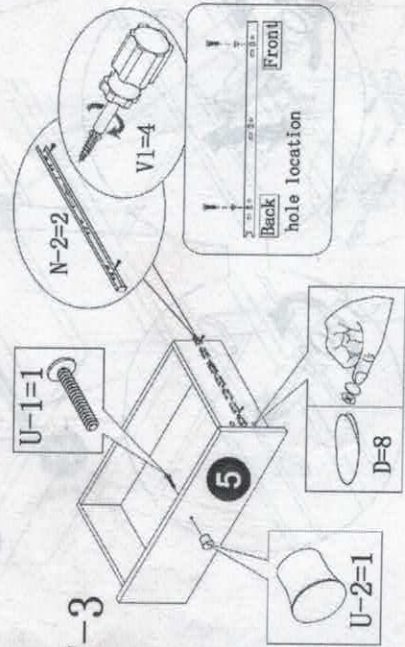

5

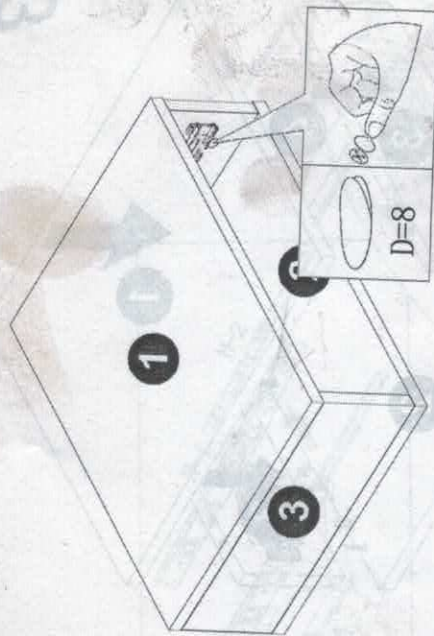

6

